



Alcatel-Lucent 8001 DeskPhone

User Manual



8AL90895USAB Ed2

INDEX

1. Getting Started	4
2. Set up the Phone	4
3. Phone User Interface	6
3.1 Hardware Component Instructions	6
3.2 Phone Screen Display Features.....	8
3.3 Basic Network Settings.....	9
3.4 SIP Account Settings.....	10
3.5 Basic Features	11
3.5.1 Making a Call	11
3.5.2 Anonymous Call.....	11
3.5.3 Redial	11
3.5.4 Call Log.....	12
3.5.5 Making Calls to Contacts	12
3.5.6 Multi-lines to Answer the Call	12
3.5.7 Auto-Answer.....	13
3.5.8 Ending a Call	13
3.5.9 Using Hold and Recover (Switch Calling Line)	14
3.5.10 Transferring Calls.....	14
3.5.11 Using Mute	15
3.5.12 Do Not Disturb.....	15
3.5.13 3-way Conference.....	15
3.5.14 Voice Mail	16
3.5.15 Lock.....	16
3.6 Advanced Settings.....	17
3.6.1 Using the phone book	17
3.6.2 Using Call Logs	19
3.6.3 Peer-to-Peer	19
3.7 Keypad Setting	20
3.7.1 Language Setting	20
3.7.2 Message.....	20
3.7.3 Time & Date.....	21
3.7.4 Ring Tone and Volume Setting	21
3.7.5 Searching Phone Book.....	22
3.7.6 Features that cannot be set with the Keypad	22
4. WEB User Interface.....	23
4.1 Network.....	24
4.1.1 LAN Port.....	24
4.1.2 PC Port.....	26
4.1.3 Advanced VPN Setting.....	26
5. SIP Account	28
5.1 Basic	28
5.2 Call.....	29
5.3 Security.....	30
6. Phone Setting.....	31
6.1 Basic	31
6.1.1 Time Settings	32
6.1.2 Call	33
6.1.3 VoIP Call Forward	34
6.1.4 QoS	35
6.2 Advanced.....	35
6.2.1 Basic.....	35

6.2.2	Advanced	36
6.3	Line Keys.....	37
6.4	Function Keys	38
6.5	Soft Key	38
6.6	Dial Plan	39
6.7	IP Strategy	40
7.	Phone Book.....	40
7.1	Group	40
7.2	Contact.....	40
7.3	LDAP	41
7.4	Ban List.....	42
8.	Phone Maintenance	43
8.1	Basic	43
8.1.1	HTTP Upgrade.....	43
8.1.2	FTP Upgrade	44
8.1.3	TFTP Upgrade	45
8.1.4	Default Setting.....	45
8.1.5	Reboot	46
8.2	Advanced.....	46
8.2.1	Log	46
8.2.2	Auto Provision	46
9.	Password.....	48
10.	WEB and Settings or Information	48
10.1	WEB User.....	48
10.2	Note Tips	49

1. Getting Started

About

Alcatel-Lucent 8001 DeskPhone is a highly innovative VoIP SIP phone. It can perfectly satisfy all kinds of business communications. Alcatel-Lucent 8001 DeskPhone integrates a 132x64 pixels graphic LCD, a large resolution display, elegant and intuitive user interface, which you can perfectly experience. Its rich features can effectively improve business communications. Alcatel-Lucent 8001 DeskPhone meets the demands of small and medium enterprise, Home Office and large enterprises.

Feature Highlights

a) Multi-Language

The LCD display supports Multi-Language.

b) HD Voice

Special voice processing technology, high-fidelity voice quality, HD encoding, HD Handset, ensure clear, realistic and smooth communication.

c) Advanced Calling Capabilities

Two lines with double color (GREEN & RED) LEDs, Synchronously control or manage 2 calls, Call queue, Switch between lines. Multi-parties conference, call transfer.

d) All kinds of Phone Book

It supports XML Personal Phone Book\LDAP\Enterprise Phone Book etc. This feature satisfies customer's phone book requirements.

e) Support of HTTP\TFTP\FTP\Auto-Provision.

f) Support of PoE and Power Adapter.

g) 2-angles adjustable bracket, wall-mountable

An adaptor is required for compliance with standard TIA-570-C, section 8

2. Set up the Phone

a) Packing List:

Check the packing list before installation, if you find anything missing, please contact your system administrator.

- 1*Alcatel-Lucent 8001 DeskPhone IP Phone
- 1*Handset
- 1* Handset Cord
- 1* Ethernet Cable

- 1* Phone Bracket
- 1* Safety sheet

b) Phone Installation:

This section introduces how to install the phone with the components available in the pack:

- Attach the Bracket
- Connect the Handset and optional Headset
- Connect the Network and Power

Attach the Bracket

Please firstly let the part 1 of the bracket join the phone by following steps "a" to "b" as shown here-after, and then let the part 2 of the bracket join the lower holder or upper holder depending on the desired phone angle: respectively high or low.

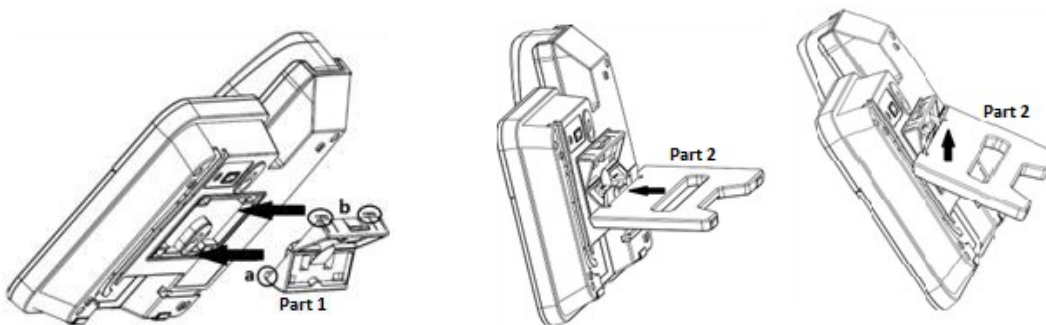

Connect the Handset and optional Headset

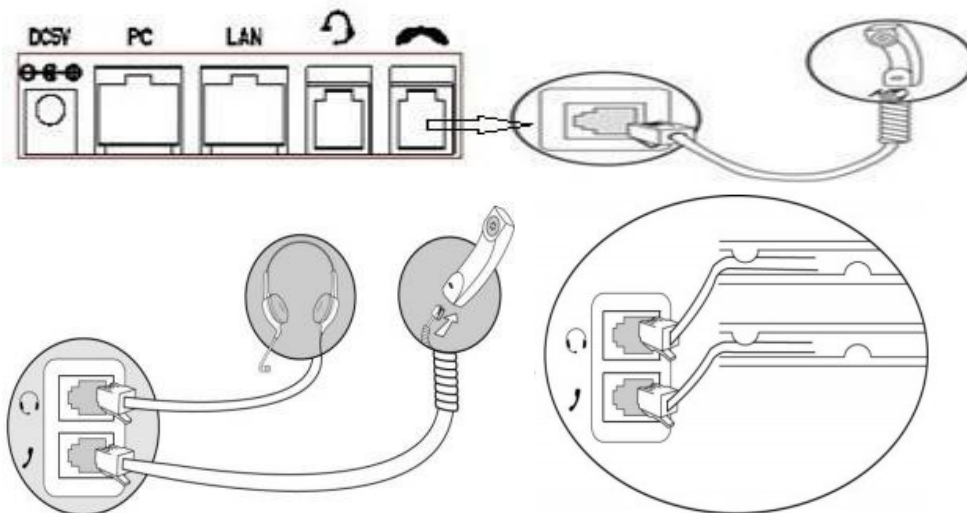

Connect the Network and Power

You have two options for power supply. Your system administrator will advise you which one to use.

- AC power adapter
- PoE(Power over Ethernet) IEEE802.3af

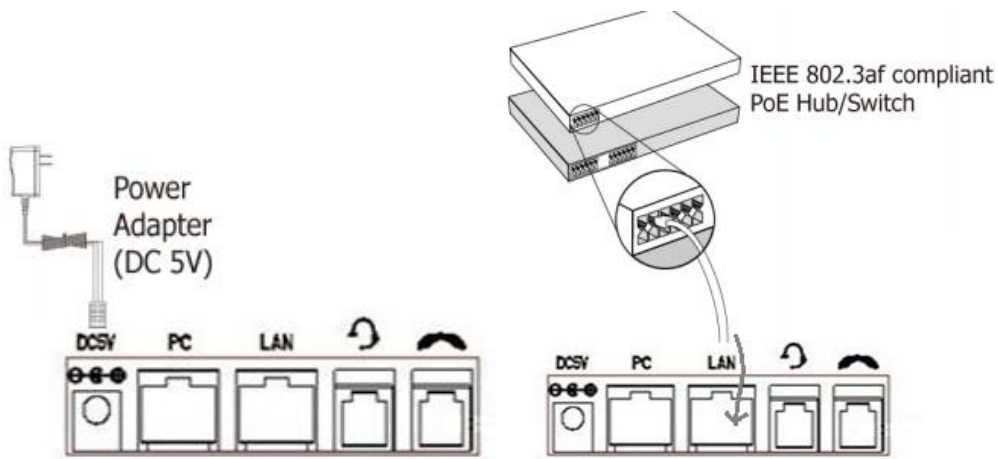

Note: If POE is available, the phone doesn't need to connect to the AC power adapter. Make sure the Ethernet cable and switch/hub is POE compliant. For Brazil, the AC power adapter is not included with the product and if necessary, an adapter INMETRO-certificated must be used.

3. Phone User Interface

3.1 Hardware Component Instructions

The main hardware components of the Alcatel-Lucent 8001 DeskPhone IP Phone are the LCD screen and the keypad.

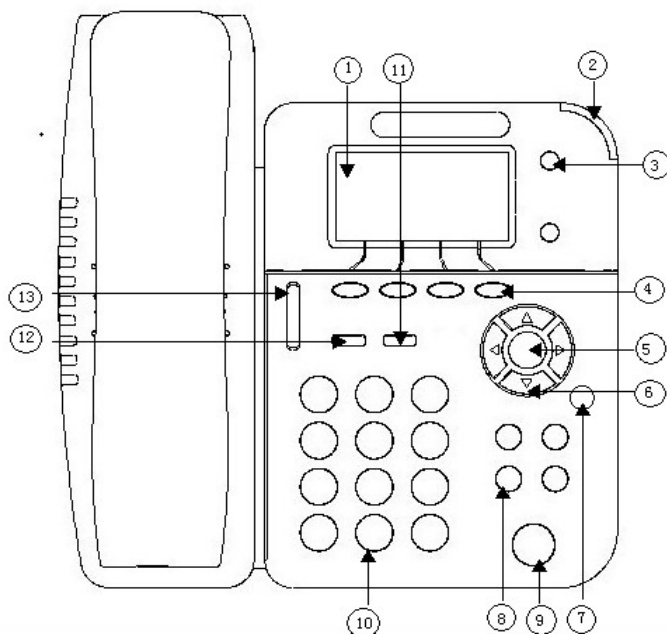

Hardware components of the Alcatel-Lucent 8001 DeskPhone are described as follows:

	ITEM	DESCRIPTION
1	LCD Screen	Displays information about calls, messages, soft keys, time, date and other relevant data: <ul style="list-style-type: none"> • Call information — caller ID, call duration • Icons (e.g. DND) • Missed calls or second incoming caller's information • Time and date
2	Light Status	Red-Flashing: There is an incoming call or an on holdcall. Red-Steady: Hook-off or in conversation
3	Line Keys	Green-Steady: There is a conversation on-going on the line Red-Flashing: There is an incoming call Green-Flashing: The line is on hold Dark: Accounts are idle
4	Soft Keys	These 4 programmable keys allow to open services or launch calls (depending on what has been configured)
5	OK Key	Confirm the action
6	Navigation Keys	Scroll through the displayed information, and in the idle state: UP: Open the "All CONTACT LOG" DOWN: Open the "MISSED CALLS" RIGHT: Open the "RECEIVED CALLS" LEFT: Open the "DIALED CALLS"
7	C Key	Cancels actions or rejects an incoming call, and the other feature: In the idle state: Open the "Phone Status". Diagnosis: Press and hold 3 seconds to open "HardwareDiagnosis". MUTE: "MUTE" feature is activated if you press this button during an ongoing conversation.
8	Functions Keys	Conference\Redial\Transfer\Hold
9	Speaker Key	Toggles the hands-free speaker phone mode.
10	Keypad	Provides the digits, letters and special characters in context-sensitive applications.
11	Headset Key	Toggles and indicates the headset mode.
12	Message Key	Indicates and accesses voice messages.
13	Volume Keys	Adjusts the volume of the handset, headset, speaker and ringer

3.2 Phone Screen Display Features

If the phone has successfully started up and is ready to use, the idle LCD display will show information as below:



	ITEM	DESCRIPTION
1	TIME & DATE	TIME & DATE display in the middle of the screen.
2	Auto-Answer icon	Enable this feature; it will display "AA" at the top right corner.
3	Missed Call	Missed Call under the TIME in the middle of screen
4	Line Status	There are four states as below: a. : the network is disconnected b. : Account registration failed c. : Account successfully registered d. : Account successfully registered and DND feature is enabled. The DND icon will also display at the top right corner.
5	Soft Key Area	These 4 programmable keys allow to open services or launch calls (depending on what has been configured)
6	Screen Top Icon	The Screen Top Icon from left to right is: : Handset active state :Speaker active state :Headset active state :Call MUTE :Missed Call :Call Forward :Text Message :Keypad Lock :Network is unavailable

3.3 Basic Network Settings

The phone supports three modes of Network Settings, including PPPoE\Static IP\DHCP.

DHCP Setting

Feature	Operating Steps
DHCP	<p>Press OK or MENU > System Settings > Advanced Settings > Password (By default Empty) > Network > LAN Port</p> <ul style="list-style-type: none"> • Press LAN Port to login in to the menu • Select "DHCP" mode • Press "Enter" key • Set the DNS\WEB Port\Telnet Port • Press "Save" key • "Network is changed, press OK reboot" message appears

Static IP Setting

Feature	Operating Steps
Static IP	<p>Press OK or MENU > System Settings > Advanced Settings > Password (By default Empty) > Network > LAN Port</p> <ul style="list-style-type: none"> • Press LAN Port to login in to the menu • Select "Static" mode • Press "Enter" key • Set the IP\Mask\GW\DNS\web port\telnet port • Press "Save" key • "Network is changed, press OK reboot" message appears

PPPoE Setting

Feature	Operating Steps
PPPoE	<p>Press OK or MENU > System Settings > Advanced Settings > Password (by default Empty) > Network > LAN Port</p> <ul style="list-style-type: none"> • Press LAN Port to login in to the menu • Select "PPPoE" mode • Press "Enter" key • Set the User Name>Password\WEB Port\Telnet Port • Press "Save" key • "Network is changed, press OK reboot" message appears

3.4 SIP Account Settings

8001 DeskPhone makes calls based on SIP accounts. It can support one account or Two-accounts. Each account can be configured to a different SIP server.

If you want to...	Then...
Create a SIP account	<p>-- 1) Select "System setting" > "Advanced setting";</p> <p>-- 2) Enter the password required (By default: empty) ;</p> <p>-- 3) Select "SIP" > "Account sip";</p> <p>-- 4) Select one of the accounts you want to set, you can configure the following parameters</p> <ul style="list-style-type: none"> - Enable account*: Select Enable - Number of lines: Default is 2 - Description: description of this account - Display Name: The name displayed on the screen - Authentication user: the Authenticated users are matched with the SIP server.(By default with the same account) - Account*: the account matches with the SIP server (extension number) - User password*: the user password matches with the SIP server - SIP Server*: The primary SIP server, all calls through this server - Out Bound Server: The outbound SIP server - STUN Type: Enable/Disable STUN feature - STUN: Input STUN URL - Auto Answer: Enable/Disable this account auto answer feature <p>* Note: When you finish the setting, you can press Save to activate it, and then you can see the status icon in the LCD idle.</p> <p> The parameters with the * mark here above must be set.</p>
Disable SIP account	<p>-- 1) Select "System setting" > "Advanced setting";</p> <p>-- 2) Enter the password required (By default empty) ;</p> <p>-- 3) Select "SIP" > "Account sip";</p> <p>-- 4) Select "Enable account" > "Disable";</p> <p>-- 5) Select "Save" to save settings</p>

3.5 Basic Features

3.5.1 Making a Call

Here are some easy ways to place a call on 8001 DeskPhone:

If you want to...	Then...	
Place a call using the handset	Pick up the handset	-- 1) You can hear dial tone; -- 2) Enter a number; -- 3) Press Dial - or wait 5 s (default value), then the 8001 DeskPhone sends the number automatically.
Place a call using a speakerphone	Press Speaker button	
Place a call using a headset	Put on your headset, by pressing Headset button so that the status light is Red  , and then do as using speakerphone	

3.5.2 Anonymous Call

You can use anonymous call feature to block the identity and phone number from showing up to the called party when making a call. E. g. you want to call to consult some of the services, but you don't want to be harassed.

Enable Anonymous Call	Press OK or MENU > Function Setting > Anonymous
	-- Press Enter or OK button , - You can select which Account you want to use, enable/disable this feature and enable/disable rejecting anonymous calls

3.5.3 Redial

To redial the last placed call from your phone

Redial	-- Press REDIAL button to dial the last number - or press Navigation button-Left > "Dialed number", select a number, and press Dial
--------	---

3.5.4 Call Log



Dial from a call log	<p>-- 1) Press MENU or OK button > "Call history", you can select "All Calls", "Missed calls", "Received calls" and "Dialed numbers",</p> <p>- or press Navigation button (in Standby interface) > select "All Calls"(up) "Missed calls"(down), "Received calls"(left) and "Dialed numbers" (right)</p> <p>-- 2) Then press Dial button.</p> <p>NOTE: You can also press the "log" to login to this menu when in the idle state.</p>
----------------------	---

3.5.5 Making Calls to Contacts

You can also dial a contact from the Personal Phone Book.

Placing Calls to Contacts	<p>-- 1) Press MENU or OK button > "Phone Book", you can select "Personal Phone Book", "Enterprise Phone Book", "LDAP" and "Black List",</p> <p>- or press Navigation button (in Standby interface) > select the desired contact.</p> <p>-- 2) Then press Dial button.</p> <p>NOTE: You can also press the "DIR" to login to this menu when in the idle state.</p>
---------------------------	---

3.5.6 Multi-lines to Answer the Call

Multi-lines to Answer the Call	<p>-- 1) Another Line button is Red  and flashing, Light strip is Red and flashing;</p> <p>-- 2) Press the flashing  Line button to answer (at this time, the original call will be put on hold.)</p>
--------------------------------	---

3.5.7 Auto-Answer

You can set the phone and let it auto-answer incoming calls.

<p>Auto-Answer the Coming Call</p>	<p>-- 1) Enable the Auto-Answer feature.</p> <p>-- 2) In Auto-Answer mode you can select one of the following options in the MENU > Function Setting > Auto Answer > Device</p> <ul style="list-style-type: none"> • Speaker • Handset • Headset <p>Note that if you use the Handset mode, you need to pick up the handset to get the call.</p> <p>-- 3) Filter Groups</p> <p>Auto-answer the incoming call from these special groups.</p>
------------------------------------	--

3.5.8 Ending a Call

To end a call, here are the options available in different contexts.

<p>Hang up while using the Handset</p>	<p>-- Return the handset to its cradle, - or press End</p>
<p>Hang up while using the Speakerphone</p>	<p>-- Press the Speaker button that is Red  - or press the Line button of the appropriate line, - or press End</p>
<p>Hang up while using the Headset</p>	<p>-- Press the Headset button, (Do not keep the headset mode), - or press End (keep the headset mode)</p>
<p>Hang up one call, but preserve another call on the other line</p>	<p>-- Press End, - or refer to the above three methods</p>

3.5.9 Using Hold and Recover (Switch Calling Line)

You can hold and resume calls. You can take a call in one line at anytime, and the other lines would be put on hold. As a result, you can switch between different calling lines on your phone.

If you want to...	Then...
Put a call on hold	-- Press the HOLD button, Hold - or press the soft key
Hold a line and switch to another line	Press another Line button for the appropriate line
Resume a call on current line	-- Press the Line button,
Resume a call on different line	Select the line you want to retrieve, then press the line button

NOTES

- Engaging the Hold feature typically generates music or a beeping tone.
- A held call is indicated by the Yellow-green  and flashing Line button or a "Hold" on the LCD.

3.5.10 Transferring Calls

Transfer redirects a connected call. The target is the number to which you want to transfer the call.

Talk to the transfer recipient before transferring a call (consult transfer)	-- 1) Press TRANSFER button or press XFER ; -- 2) Enter number; -- 3) press Send then transfer the call, - or wait five seconds (default value) then transfer the call
Transfer to idle lines or other numbers without talking to the transfer recipient (Blind transfer)	-- 1) Press TRANSFER button or XFER ; -- 2) Press Blind -- 3) Enter number; -- 4) press Send , then transfer the call; - or wait five seconds(default)then transfer the call Notes: today's Alcatel-Lucent OXO system does not support blind transfer feature on 8001 DeskPhone
Blind transfer to the held line	-- 1) Press TRANSFER button or press XFER ; -- 2) Press the Line button of the held line





3.5.11 Using Mute

With Mute enabled, you can hear other parties on a call but they cannot hear you. You can use mute in conjunction with the handset, speakerphone, or a headset.

Toggle Mute on	Press C button, a MUTE icon  will appear on the top left of the screen
Toggle Mute off	Press C button again, the MUTE icon disappears

3.5.12 Do Not Disturb

You can use the Do Not Disturb (DND) feature to block incoming calls on your phone with a busy tone (Can also be set to voice mail or other extension numbers, etc.).

Enable global DND	-- 1) Press DND; -- 2) All enabled line on the phone would change to  status and the icon is  .
Enable DND on a single line	Press MENU or OK button > "Function setting" > "DND" > (select line) "Enable"
Disable DND	-- Global DND enabled, press  to disable global DND; -- Line DND enabled, press twice  , - or press MENU or OK button > "Function setting" > "DND" > (select line) "Disable"

3.5.13 3-way Conference

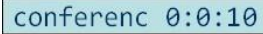

You can enable a three-party conference, during the conversation, the three phone parties can communicate with every other party.

If you want to...	Then...
Invite the transfer recipient into a conference	-- 1) When the transfer recipient answers the call, press CONFERENCE button or "CONF" on your phone; -- 2) Then the held one, the transfer recipient and yourself will be into a conference, and the LCD will display  status.

Invite the third party into a conference in an active call	-- 1) Press " CONFERENCE " button or "CONF" in an active call; -- 2) Enter the third party number; -- 3) After connection with the third party, press " CONFERENCE " button or "CONF" again
Establish a conference with held line	-- 1) when one phone line is on-hold and the other line is busy, press " CONFERENCE " button, - or Press "CONF" Soft key -- 3) Press the held line's programmable button, the 3-way Conference is enabled.

3.5.14 Voice Mail

When the phone gets a voice mail from server, it will light up the voice mail button 

Voice Mail	--1) Press the Voice Mail button (When Voice Mails are available, icon is  , when no message, icon is  -- 2) Enter the User Password -- 3) The phone will login in to the voice mail server. You may need to follow the instructions to listen to your messages.
------------	--

3.5.15 Lock

You can enable/disable lock function thru MMI, when lock feature is enabled, a lock icon will be shown in the main screen.

Lock	-- 1) Menu -> System Settings -> Phone Settings -- 2) Enter "Keypad Lock", click soft key "Shift" or left/right arrow key to choose the options: <ol style="list-style-type: none"> 1. "Lock All" means all the keys in phone set will be locked 2. "Lock & Auto Answer" means all the keys will be locked while in auto answer mode it will be unlocked 3. "Lock Menu" means the "Menu" soft key will be locked 4. "Lock Function" means the function keys will be locked, while the dialing pad will be in un-lock status 5. "Disable" means disable the "Lock" feature -- 3) "Phone Lock Time Out" is used to set the interval how long the set will be locked again after you unlock the set -- 4) The lock password is controlled by Alcatel-Lucent SIP server Notes: Lock feature is a user oriented feature, if the phone set is locked, user can unlock the status thru MMI and the phone set always keeps in un-lock until you unlock it thru MMI. The password of lock can be configured thru solution, like OmniVista 8770 .
------	--

3.6 Advanced Settings

3.6.1 Using the phone book

Enterprise Phone Book

Search a Contact from Enterprise Phone Book	-- 1) Press DIR in the idle status, - or press " MENU " or " OK " button > "Phone book" > "Enterprise Phone Book", -- 2) Select "Enterprise Phone Book", press " OK " button; -- 3) Press "Find" and input the name who you want to search.
Call a Contact from Enterprise Phone Book	--1) Press "DIR" in the idle status, - or press " MENU " or " OK " button > "Phone book">"Enterprise Phone Book", -- 2) Select "Enterprise Phone Book", press " OK " button; -- 3) Press "Find" and input the name who you want to search. -- 4) When you find the right contact, you can launch the call.

Personal Phone Book

Add a Contact	-- 1) Press Phone Book, - or press " MENU " button > "Phone book" > "Personal phone book > View All", -or press " OK " button > "Phone book" > "Personal phone book > View All"; -- 2) Select "Add contact", press " OK " button; -- 3) Use the navigation keys to select content, press " OK " button to set and modify: - Name: set the name of contact, - Office Number: Set the contact Office Number - Mobile Phone Number: Set the contact Mobile Phone Number - Others Numbers: Set the contact Others Numbers - SIP Account: Set the contact call SIP account - Group: the contact will be placed into one of the user's groups -- 4) Press " Save " soft key to complete
---------------	---

Add group	<p>-- 1) Press "DIR" soft key, - or press "MENU" button > "Phone book" > "Personal phone book > View All", - or press "OK" button > "Phone book" > "Personal phone book > View All";</p> <p>-- 2) Select the "add group" then press OK button;</p> <p>-- 3) Use the navigation keys to select content, press OK button to set and modify: - Group name: name of the group</p> <p>--4) Press "Save" soft key to complete</p>
Modify group	<p>--1) Press "DIR" soft key, - or press "MENU" button > "Phone book" > "Personal phone book > View All", - or press "OK" button > "Phone book" > "Personal phone book > View All";</p> <p>-- 2) Select the "Modify group" then press "OK" button ;</p> <p>-- 3) Select the group you want to modify, press the "OK" button to set and modify, press "Save" to save the change</p>
Delete group	<p>-- 1) Press "DIR" soft key, - or press "MENU" button > "Phone book" > "Personal phone book > View All", - or press "OK" button > "Phone book" > "Personal phone book > View All";</p> <p>-- 2) Select the "Delete group" or OK button;</p> <p>-- 3) Select the group you want to delete, press OK button</p>

LDAP

Search a Contact from LDAP	<p>-- 1) Press "DIR" in the idle status, - or press "MENU" or OK "button" > "Phone book" > "LDAP",</p> <p>-- 2) Select "LDAP", press "OK" button;</p> <p>-- 3) Press "Find" and enter the name or number you want to find in the LDAP server.</p>
Call a Contact from LDAP	<p>-- 1) Press "DIR" in the idle status, - or press "MENU" or "OK" button > "Phone book" > "LDAP",</p> <p>-- 2) Select "LDAP", press "OK" button;</p> <p>-- 3) Press "Find" and enter the name or number you want to find in the LDAP server.</p> <p>-- 4) When you find the right contact, you can then launch the call</p>

Black List

Add a Contact to the Black List	<ul style="list-style-type: none"> -- 1) Press "DIR" in the idle status, - or press "MENU" or "OK" button > "Phone book" > "Black List", -- 2) Select "Black List", press "OK" button; -- 3) Press "Add" and enter the name \ office number \ mobile number \ other number \ SIP account you want to add into the Black List.
View a Contact in the Black List	<ul style="list-style-type: none"> -- 1) Press "DIR" in the idle status, - or press "MENU" or "OK" button > "Phone book" > "Black List", -- 2) Select "Black List", press "OK" button; -- 3) Press "OPT" to view a contact in the list. -- 4) If you want to move a contact or change it, you can follow the "OPT" to do so.

3.6.2 Using Call Logs

Your phone maintains records of your missed, placed, and received calls.

View call logs	<ul style="list-style-type: none"> -- 1) Press "MENU" or "LOG" button > "All Call" > "Missed Calls", "Received Calls", or "Dialed numbers" -- 2) Use the navigation keys to view the call record information.
Delete/Save Call Logs	<ul style="list-style-type: none"> -- 1) Login in to the Call Logs -- 2) Use the navigation keys to view the call record or select DEL key. -- 3) Use the navigation keys to view the call record or select Save key.

3.6.3 Peer-to-Peer

When all of the phone accounts (two accounts) are disabled on the 8001 DeskPhone, or when the 8001 DeskPhone has not registered successfully to a server, the 8001 DeskPhone is in 'peer to peer' state.

Peer-to-Peer	Disable all of accounts or not register.
Make Call with Peer-to-Peer	<ul style="list-style-type: none"> -- 1) Press OK or MENU button > System Setting > Advanced Setting > SIP Account; -- 2) Disable all of accounts or un-register; -- 3) Turn back the phone to idle state, you can call another party using his IP address.

3.7 Keypad Setting

Alcatel-Lucent 8001 DeskPhone offers two ways to configure the keypad. One is setting through the local MENU, and the other is setting through the website management. Here is the description through the local MENU.

NOTES: When you want to enter a "." e.g. for the IP address, please use the "*".

3.7.1 Language Setting

Alcatel-Lucent 8001 DeskPhone supports Multi-Language setting, here below an example.

Switch the Language	<ul style="list-style-type: none"> -- 1) Press OK or MENU button> System Setting> Phone Setting> Language -- 2) Here you can select Czech\ Danish\ Dutch\English\Estonian\Finnish\French \German\Greek \Hungarian \Hebrew\Icelandic\Italian \Latvian \Norwegian \ Korean\Lithuanian\ Polish\Portuguese\Portuguese-Brazil\ Russian\ Spanish\ Slovak\Slovenian \ Swedish \Turkish (in Great China version,8001DeskPhone also supports Chinese and traditional Chinese) -- 3) After language selection, press Save.
---------------------	--

3.7.2 Message

Alcatel-Lucent 8001 DeskPhone has a Messaging feature. It will display on the LCD when you receive a New Message.

Create a Message	<ul style="list-style-type: none"> -- 1) Press OK or MENU button; -- 2) Select "Messaging" -- 3) Voice Message: Setting the Voice Message code in here. Text Message: Write down the Text Message in here. -- 4) Select Text Message> New Message. -- 5) Input the receiver and write down the message body, and then press Send.
Message Inbox	<ul style="list-style-type: none"> -- 1) Select Message Inbox. -- 2) Select which message you want to check. -- 3) You can press Enter to read or press Del to delete.

3.7.3 Time & Date

SNTP	<p>-- 1) Press OK or MENU button;</p> <p>-- 2) Press OK or MENU button > System Setting> Phone Setting > Time & Date > Time and Date setting > SNTP</p> <p>-- 3) SNTP</p> <ul style="list-style-type: none"> - Time Zone: Setting the time zone - NTP Server 1: NTP server address1 - NTP Server 2: NTP server address2 - DayLight: Enable/Disable Day Light
SIP Server	<p>-- 1) Press OK or MENU button;</p> <p>-- 2) Press OK or MENU button > System Setting > Phone Setting > Time & Date > Time and Date setting > SIP Server</p> <p>-- 3) Press Save</p>
Manual Setting	<p>Press OK or MENU button;</p> <p>-- 2) Press OK or MENU button > System Setting > Phone Setting > Time & Date > Time and Date setting > Manual Setting</p> <p>-- 3) Manual Setting</p> <ul style="list-style-type: none"> - Manual Setting: Year\Month\Days\Hours\Minutes\Seconds
Time Display Format	<p>-- 1) Press OK or MENU button;</p> <p>-- 2) Press OK or MENU button > System Setting > Phone Setting > Time & Date > Time Display Format</p> <p>--3) Time Mode: 24hour\12hour Date mode:</p> <p>DDMMWWW\MMDDWWW\WWWDDMMM\DDMMMYY\YYYYMMDD\DDMMYYYY\MDDYY\DDMMYYYY\WWWDDMMM etc. (WWW mean day of week, Mon, Tue, Wed, ...)</p>

3.7.4 Ring Tone and Volume Setting

Ring Type	<p>--1) Press OK or MENU button> System Setting > Phone Setting > Ring Type</p> <p>-- 2) Select the ring type from 1 to 8 or custom ring, and then press Save.</p>
Volume Setting	<p>-- 1) Press OK or MENU button;</p> <p>-- 2) Press OK or MENU button > System Setting > Phone Setting > Volume Setting</p> <p>-- 3) Volume Setting: Handset\Speaker\Headset\Ring volume</p> <p>-- 4) Press Enter to adjust the volume and press Save</p>

NOTES: For the Custom Ring Type you need to upload it through website.

3.7.5 Searching Phone Book

Accurate Search	-- 1) Press MENU or OK button > "Function Setting", you can select " Accurate Search " -- 2) Then press Enable/Disable and Save. -- 3) When you are back to idle state, you can use the digital keypad to search the contact.
T9 Search	-- 1) Press MENU or OK button > "Function Setting", you can select " T9 search" -- 2) Then press Enable/Disable and Save. -- 3) When you are back to idle state, you can use the digital keypad to search the contact using T9 method.

NOTES: The Search Phone Book setting default is Accurate Search.

3.7.6 Features that cannot be set with the Keypad

Below features cannot be set with the keypad:

- 1) Dial Plan
- 2) Custom Ring Type
- 3) Update the Firmware or Backup the configuration file.

4. WEB User Interface

In addition to the phone user interface, you can also customize your phone via the web user interface. In order to access the web user interface, you need to know the IP address of your new phone. To obtain the IP address, press the "C" key on the phone. Enter the IP address (e.g. HTTP://192.168.0.10 or 192.168.0.10) in the address bar of the web browser on your PC. The default user name is root (case-sensitive) and the default password is root (case-sensitive), if the 8001 DeskPhone is managed by OmniVista 8770, the password "root" can be set in system side.

Main Interface-Phone Status

Here-below you can see the home page: System Run Time, Registration Status, Network Status, System Information:

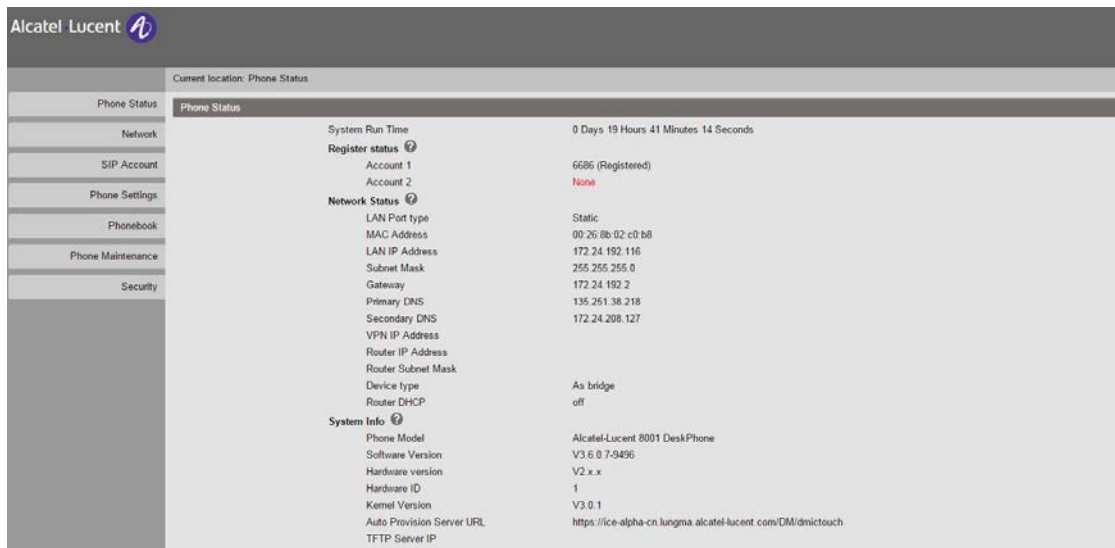

ITEM	DESCRIPTION
System Run Time	The phone system normal running time.
Register Status	The registration status of Account 1~3.
Network Status	The status of LAN, MAC, LAN IP, Net mask, Gateway, Primary DNS, Secondary DNS, VPN IP, PC IP, PC Net mask, Device Type, DHCP Server.
System Information	The status of Phone Model, Software Version, Hardware Version, Hardware ID, Kernel Version, Auto-Provision Server URL, TFTP Server IP.

4.1 Network

4.1.1 LAN Port

Basic

Basic >>

DHCP ?

Hostname(Option 12)

Manufacturer(Option 60)

Static IP ?

IP Address

Netmask

Gateway

PPPoE ?

Username

Password

MTU Default: 1500

DNS Settings

DNS Automatic Manual DNS

Primary DNS

Secondary DNS

ITEM	DESCRIPTION
Network Connection Mode	Network Connection Mode can be DHCP, Static IP, or PPPoE.
DNS Settings	Select the DNS mode that you want and enter the Primary and Secondary DNS addresses.

Advanced

Port Management Settings

HTTP Port

Telnet Port

Socket5 Proxy Server

Socket5 Proxy Server off on

Server IP *

Port *

Anonymous Login

Username

Password

Paging Setting

Paging 1 off on

Group IP Port:

Paging 2 off on

Group IP Port:

Paging 3 off on

Group IP Port:

Paging 4 off on

Group IP Port:

Paging 5 off on

Group IP Port:

Please Note: Changing the default HTTP Port (80) will require using the new port number to access the IP phone web interface. Please note that changes require a reboot. Use the following format when not using the default HTTP (<http://ip address:portnumber>).

ITEM	DESCRIPTION
Port Management Settings	
HTTP Port	The default web port is 80,if you want to change it (for example change to 88), You must input IP and Web port to login to the web page (for example HTTP://192.168.0.200:88). It will take effect on the next reboot.
Telnet Port	The default Telnet port is 23,if you want to change it (for example change to 2003). You must input IP and Telnet port to login to the management page (for example telnet 192.168.0.200:2003).It will take effect on the next reboot.
Socket5 Proxy Server	

Socket5 Proxy Server	Enable/Disable Socket5 Proxy Server.
Server IP	Socket5 Proxy Server IP address.
Port	Socket5 Proxy Server port, default is 1080.
Anonymous Login	Enable/Disable Socket5 Proxy Server login username.
Paging Setting (NOTE: This feature priority is followed the serial number, In other words, "paging 1" is the highest priority)	
Paging1	Enable/Disable Paging feature.
Group IP and Port	Group IP and Port with Paging.

4.1.2 PC Port

Normally choose Bridge, if you choose Router, you need to input router IP address, net mask.

The screenshot shows a configuration panel for PC Port. At the top, there are two radio buttons: 'Bridge' (selected) and 'Router'. Below these are several input fields: 'IP Address' and 'Netmask' (both marked with an asterisk), 'DHCP Server' (with radio buttons for 'off' and 'on'), 'Start IP', and 'End IP'.

Bridge

Normally, you should choose "bridge" feature, it means that PC port and LAN port will share the same network.

Router

Router feature is for the phone PC Port. You must input IP address (it's equivalent to a gateway) and Net mask. If you want to use DHCP function, please turn it on, input start IP and end IP.

4.1.3 Advanced VPN Setting

VPN Setting

The screenshot shows the 'VPN Settings' configuration panel. It includes a checkbox for 'Enable VPN', a dropdown menu for 'VPN Type' (set to 'L2TP'), and three input fields for 'VPN Server Addr', 'VPN Username', and 'VPN Password'.

When using VPN Setting option, you can set several parameters as follow:

VPN Setting	
Enable VPN	You can enable/disable VPN for phone and PC.
VPN Type:	Choose the appropriate type of VPN.
VPN Server Addr	VPN server IP address.
VPN User Name	VPN user name
VPN Password	The password is used for authentication

VLAN Setting

Enable Vlan:	<input type="checkbox"/>		
LAN Port		PC Port	
VID:	<input type="text" value="0"/> (0~4094)	VID:	<input type="text" value="0"/> (0~4094)
Priority:	<input type="text" value="0"/> (0~7)	Priority:	<input type="text" value="0"/> (0~7)

When using VLAN Setting option, you can set several parameters as follow:

VLAN Setting	
Enable VLAN	You can enable/disable VLAN for phone and PC
VID [LAN/PC Port]	The VLAN ID you want the phone or PC to join

5. SIP Account

5.1 Basic



Enable	<input checked="" type="checkbox"/>
Account Mode	VOIP
Amount Of Line Account Used	1 (Default: 2)
Display Name	<input type="text"/>
Username	5207 *
Authenticate Name	5207
Password	•••• *
Label	<input type="text"/>
SIP Server	192.168.0.7
Secondary server	<input type="text"/>
OutboundProxy Server	<input type="text"/>
Secondary OutboundProxy Server	<input type="text"/>
Polling Interval Time Of Registration	32 s Default Value: 32s, Range: 20s~~60s
NAT Traversal	Disable
STUN Server	<input type="text"/>
BLA	<input checked="" type="radio"/> off <input type="radio"/> on
BLA Number	<input type="text"/>
Subscribe Period	1800 Default: 1800s, Min: 120s
Register Expire Time	3600 Default: 3600s, Min: 40s
Auto Answer	<input checked="" type="radio"/> off <input type="radio"/> on
SIP Transport	<input checked="" type="radio"/> UDP <input type="radio"/> TCP <input type="radio"/> TLS
Ring Type	None

Choose one Account, you will find the following parameters:

ITEM	DECSRIPTION
Enable	You can choose on/off to enable/disable the line.
Account Mode	Keep this selection on VOIP
Amount Of Line Account Used	This is the number of accounts used, default is 2
Display Name	This entry is shown as Caller ID when the user makes a phone call

Username	This is a username provided by SIP Server
Authenticate Name	This is the ID for authentication
Password	This is a password provided by SIP Server
Label	Label for this account.
SIP Server	Server for registration, provided by the administrator
Secondary server	When the main server is not available, this device can register to this secondary server.
Outbound Proxy Server	Address of the outbound proxy server.
Secondary Outbound Proxy Server	When the main outbound server is not available, this device can use this secondary outbound proxy server.
Polling Interval Time Of Registration	Polling Interval Time Of Registration, default is 32 s.
NAT Traversal	Defines whether the STUN server should be active or not
STUN Server	Session Traversal Utilities for NAT (STUN) server address
BLA	Bridge Line Appearance (BLA), also named Shared Line Appearance (SLA) With this BLA configuration, the 8001 DeskPhone set monitors a shared line status(this feature highly depends on SIP server status)
BLA Number	BLA Number
Subscribe Period	Subscription expiration time.
Register Expire Time	Interval after which the IP phone automatically re-registers
SIP Transport	There are three options; UDP/TCP/TLS
Ring Type	Select the ringing type for this account.

5.2 Call

Do Not Disturb	<input checked="" type="radio"/> off <input type="radio"/> on
Anonymous Call	<input checked="" type="radio"/> off <input type="radio"/> on 
Anonymous Call Rejection	<input checked="" type="radio"/> off <input type="radio"/> on 
Use Session Timer	<input checked="" type="radio"/> off <input type="radio"/> on
Session Timer	<input type="text" value="300"/> (min:150s)
Call Method	<input checked="" type="radio"/> SIP <input type="radio"/> TEL
DNS-SRV	<input checked="" type="radio"/> off <input type="radio"/> on
Allow-events	<input checked="" type="radio"/> off <input type="radio"/> on
Registered NAT	<input type="radio"/> off <input checked="" type="radio"/> on
UDP Keep-alive Message	<input checked="" type="radio"/> off <input type="radio"/> on
UDP Keep-alive Interval	<input type="text" value="30"/> (15-60s)

ITEM	DESCRIPTION
Call	
Do Not Disturb	Enable/Disable Do Not Disturb
Anonymous Call	Enable/Disable anonymous call.
Anonymous Call Rejection	Enable/Disable anonymous call rejection.
Use Session Timer	Enable/Disable refresh session function. The device will send an Invite packet to refresh the session during a call if this option is enabled.
Session Timer	The refresh session time interval.
Call Method	This method includes SIP and TEL.
DNS-SRV	Enable/Disable DNS-SRV.
Allow-events	Enable/Disable Allow-events.
Registered NAT	Enable/Disable Registered to NAT
UDP Keep-alive Message	The phone periodically sends a UDP packet to keep the port active and to avoid the server to shut down the port
UDP Keep-alive Interval	Default interval is 30 second.

5.3 Security

SIP Encryption	<input checked="" type="radio"/> off <input type="radio"/> on ?
RTP Encryption	<input checked="" type="radio"/> off <input type="radio"/> on ?
Encryption Algorithm	RC4 v
Encryption Key	<input type="text"/>

ITEM	DESCRIPTION
Security	
SIP Encryption	Enable/Disable SIP encryption.
RTP Encryption	Enable/Disable RTP encryption.
Encryption Algorithm	The encryption algorithm, at this time we only have RC4.
Encryption Key	The key for encryption.

6. Phone Setting

6.1 Basic

BackLight	<input type="radio"/> off <input type="radio"/> Always On <input checked="" type="radio"/> timer <input type="text" value="60"/> s (Min:1, Max:255) ?
Keyboard Lock	<input type="text" value="Disabled"/> ?
Hot Line Function	<input checked="" type="radio"/> off <input type="radio"/> Delay <input type="text" value="5"/> s (0-30)
Hot Number	<input type="text"/> ?
Auto Answer	<input checked="" type="radio"/> off <input type="radio"/> on <input type="radio"/> Turn On But Filter This Group: <input type="text" value="NONE"/> ?
Auto Answer Mode	<input checked="" type="radio"/> Hands Free <input type="radio"/> Handle <input type="radio"/> Headset
Call Waiting	<input type="radio"/> off <input checked="" type="radio"/> on ?
Call Waiting Tone	<input type="radio"/> off <input checked="" type="radio"/> Play on currently active device Frequency: <input type="text" value="10"/> s (5-60) ?
DTMF	<input checked="" type="radio"/> RFC 2833 <input type="radio"/> Inband <input type="radio"/> SIP Info <input type="radio"/> Auto ?
Fuzzy Search	<input checked="" type="radio"/> off <input type="radio"/> on
Phonebook Search	<input checked="" type="radio"/> Accurate Search <input type="radio"/> T9
Call List Save	<input type="radio"/> off <input checked="" type="radio"/> on
Network Packet Mirroring	<input type="text" value="Off"/> ?

ITEM	DESCRIPTION
Basic	
Back Light	The backlight of the phone LCD: always off, always on or period to switch off.
Keyboard Lock	Enable/Disable keyboard lock, you can lock: MENU Key, FUNCTION Keys, ALL Keys, you can also LOCK all keys but auto answer calls.
Hot Line function	When you pick up the handset, it will dial out with the hot number, after a programmable interval.
Hot Number	Input the number what you want to automatically dial as hot number.
Auto Answer	Enables/disables Auto-answering incoming calls. You can select to filter a contact group.
Auto Answer Mode	Defines the audio mode when Auto-answering an incoming call.
Call Waiting	When there is an incoming a call while the phone is already in a call, the second call will enter a queue.
Call Waiting Tone	Select the frequency for the tone when a call is waiting.
DTMF	The DTMF transmission mode, includes RFC2833,Inband,SIP Info, Auto
Fuzzy Search	Fuzzy search (with pattern) someone in the phone book in the idle mode.
Phone Book Search	Choose the phone book search feature between accurate or T9 mode.

Call List Save	You can choose to save the call list into the phone or not.
Network Packet Mirroring	When you select on, then you can capture the phone's packets using a notebook connected to the PC port of the phone

6.1.1 Time Settings

Time Settings >>

Set time mode SNTP SIP Server Manual

SNTP server 135.251.235.214 ?
 sparky.services.adelaide.edu.au List
 Manual

SNTPSecondary server
 sparky.services.adelaide.edu.au List
 Manual

Time zone-GMT GMT+08:00 Beijing ?

Update Interval (seconds) 60 ?

Time Format 24 Hour 12 Hour ?

Date Format DD MM WWW ?

Manual settings 2015 Year 1 Month 1 Days 10 Hours 0 Minutes 00 Seconds

ITEM	DESCRIPTION
Time Settings	
Set Time Mode	Select between SNTP/SIP Server/Manual
SNTP Server	You can select in the list or input your own SNTP server address.
Update Interval	The update interval with SNTP.
Day Light Saving Time	Enable/disable the Daylight Saving Time for the phone
Time Format	You choose either 24 hour time format or 12 hour time format
Date Format	You can choose the appropriate date format.
Time Zone-GMT	You can select the time zone for the phone
Manual Setting	Setting time manually.

6.1.2 Call

Pickup Function	<input type="radio"/> off <input checked="" type="radio"/> on
Pickup Code	<input type="text" value="123"/>
Message	<input type="text" value="*97"/>
Booking Voicemail	<input type="text" value="No"/> ▾
Play Voicemail Tone	<input checked="" type="radio"/> off <input type="radio"/> on
Miss Call Display	<input type="radio"/> off <input checked="" type="radio"/> on
DND Softkey	<input type="radio"/> off <input checked="" type="radio"/> on
Play Hangup Tone	<input type="radio"/> off <input checked="" type="radio"/> on
Transfer Code	<input checked="" type="radio"/> off <input type="radio"/> on Number: <input type="text"/>
Conference Exit Result	<input checked="" type="radio"/> Disconnect All <input type="radio"/> Others Remain Connected
Return code when refuse	<input type="text" value="603(Decline)"/> ▾ ?
Return code when DND	<input type="text" value="603(Decline)"/> ▾ ?
Flash hook time(<800ms)	<input type="text" value="500"/>
Called No AnswerTime	<input type="text" value="70"/> s (Min:20, Max:99)
Pound Send Method	<input checked="" type="radio"/> # <input type="radio"/> %23
RFC 2833 PayLoad	<input type="text" value="101"/>
P-Asserted-Identity	<input type="radio"/> off <input checked="" type="radio"/> on
SIP Session Timer(seconds) T1	<input type="text" value="0.5"/> ?
SIP Session Timer(seconds) T2	<input type="text" value="4"/> ?
SIP Session Timer(seconds) T4	<input type="text" value="5"/> ?
Local SIP port	<input type="text" value="5060"/> (Default: 5060)
RTP Port Range	<input type="text" value="10000"/> – <input type="text" value="10128"/>
Affiliated Port	<input type="radio"/> off <input checked="" type="radio"/> on
Headset Mode	<input checked="" type="radio"/> Normal <input type="radio"/> Seat Mode
Ring Type On Seat Mode	<input checked="" type="radio"/> Headset <input type="radio"/> Speaker

ITEM	DESCRIPTION
Call	
Pickup Function	Allows other users to answer your incoming calls.
Pickup Code	Fill in server's pickup code.
Message	Fill in voice mail's access code.
Booking Voice Mail	By enabling this feature, the phone message light will be lit when you receive a voice message.
Play Voice Mail Tone	By enabling this feature, the phone will ring when you receive a message.
Miss Call Display	Turn on or off the option to display Missed calls on the phone screen.
DND Soft key	Enable/Disable the Do Not Disturb feature.
Play Hang-up Tone	Enable the tone for hang up when busy.
Transfer Code	The code for transfer feature.

Conference Exit Result	Choose what should happen when the Conference originator hangs up: either keep the communication between the two other parties, or hang up the whole conference.
Return Code When Refuse	Select the code to feedback to the server when you reject the call.
Return Code When DND	Select the code to feedback to the server when you a call is rejected because of your DND function enabled.
Flash Hook Time (< 800 ms)	The time for the flash hook.
Called No Answer Time	When you receive an incoming call while this feature is enabled, and if you don't answer the call, the caller will receive a time out after the here-defined "Called No Answer Time" has elapsed.
Pound Send Method	Following RFC2396, the "#" will be interpreted as '#' or as %23 in the SIP request method, depending on what you define here.
RFC 2833 Play Load	Default is 101, RTP Payload for DTMF Digits, Telephony Tones and Telephony Signals
P-Asserted-Identity	Enable/Disable the P-Asserted-Identity feature.
SIP Session Timer T1	The SIP Session Timer T1 settings.
SIP Session Timer T2	The SIP Session Timer T2 settings.
SIP Session Timer T4	The SIP Session Timer T4 settings.
Local SIP Port	The port range settings for SIP, default is 5060.
RTP Port Range	The port range for RTP
Affiliated Port	Enable/Disable the affiliated port feature.
Headset Mode	Select headset mode as normal or seat.
Ring Type On Seat Mode	Select ring type mode with headset or speaker.

6.1.3 VoIP Call Forward

Always off on Number: ?
 If Busy off on Number: ?
 If No Answer off on Number: ?
 Ring Frequency Seconds (Default: 15s, Max: 15s)

ITEM	DECSRIPTION
Always	Always transfer the incoming calls (enter the destination number).
If Busy	If the phone is busy, the call will be transferred (enter the destination number).
If No Answer	If the call is not answered, the call will be transferred (enter the destination number).

Ring Frequency	Here you define the time interval before an incoming call is forwarded (when forward "if no answer" is enabled)
----------------	---

6.1.4 QoS

SIP Qos	<input type="text" value="26"/>	(0-63)
Voice Qos	<input type="text" value="46"/>	(0-63)

ITEM	DECSRIPTION
SIP QoS	The range is 0~63,default is 26
Voice QoS	The range is 0~63,default is 46

6.2 Advanced

6.2.1 Basic

Tone 

Select Country 

Ring Volume(0~9)

Output Volume(1~9)

Handset Volume

SpeakerPhone Volume

Headset volume

Input Volume(1~7)

Handset Mic Volume

SpeakerPhone Mic Volume

Headset Mic Volume

ITEM	DECSRIPTION
Basic	
Select Country	Select the country dial tone. Default is United States.
Ring Volume	The ring volume default is Level 3, the range is 0~9.
Handset Volume	The handset volume default is Level 5, the range is 1~9.
Speaker Phone Volume	The speaker volume default is Level 5, the range is 1~9.
Headset Volume	The headset volume default is Level 3, the range is 1~9.
Handset MIC Volume	The handset MIC volume default is Level 3, the range is 1~7.

Speaker Phone MIC Volume	The speaker MIC volume default is Level 3, the range is 1~7
Headset MIC Volume	The headset MIC volume default is Level 3, the range is 1~7

6.2.2 Advanced

Ring ?

Ring Type: Ring1

Uploading Ring Tone:

(Please upload a ring tone with G711A audio coding, Maximum 10 rings and the total sizes must less than 150k.)

Up << disableCode
Down >>

Audio Codecs ?

Jitter Buffer ?

Type: Adaptive Fixed

Min Delay:

Max Delay:

Normal Delay:

Other

Payload Length: ms

High Rate of G723.1:

VAD: ?

Echo Suppression Mode:

SideTone:

ITEM	DESCRIPTION
Ring	
Ring Type	Select the ring type. Default is Ring 1.
Uploading Ring Tone	Please upload a ring tone with G711A audio coding, Maximum 10rings and the total size must be less than 150k.
Audio Codec	Use the navigation keys to highlight the desired one in the Enabled/Disable Codes list, and press the <input type="button" value=">>"/> / <input type="button" value="<<"/> to move to the other list.
Jitter Buffer	
Type	The type of Jitter Buffer is Adaptive or Fixed, default is adaptive.
Min Delay	The min delay range setting, default is60.
Max Delay	The max delay range setting, default is150.
Normal Delay	The normal delay range setting, default is 120.

Other	
Payload Length	The payload length setting, default is 30ms.
High Rate Of G723.1	Enable/Disable High Rate of G723.1 feature.
VAD	Enable/Disable VAD feature.
Echo Suppression Mode	Enable/Disable Echo Suppression Mode feature.
Side Tone	Enable/Disable Side Tone feature.

6.3 Line Keys

	Mode	Account	Name	Number
Key1:	Line	Account1		
Key2:	Line	Account1		
Key3:	Line	Account1		

line keys >>

	Mode	Account	Name	Number
Key1:	Line	Account1		
Key2:	Speed Dial	Account1		
Key3:	Speed Dial Prefix	Account1		
	DTMF			
	BLF			
	Paging			
	Call Park			
	Intercom			
	BLA			

Function Keys >>

ITEMS	DESCRIBES
Line	Line is the default value.
Speed Dial	You can use this key feature to speed up dialing the numbers that are often used or hard to remember.
Speed Dial Prefix	You can use this key feature to speed up dialing a specific prefix number.
DTMF	You can use this key feature to send arbitrary key sequences via DTMF.
BLF	You can use the BLF (Busy Line Field) feature to monitor a specific user for status changes on the phone.
Paging	You can use multicast paging to forward time sensitive announcements out to people within the multicast group.
Call Park	You can use call park feature to place a call on hold, and then retrieve the call from another phone in the system (for example, a phone in another office or conference room).
Intercom	You can press the configured intercom key to automatically connect with a remote extension for outgoing intercom calls, and the remote extension will automatically answer the incoming intercom calls
BLA	Bridge Line Appearance (BLA), also named Shared Line Appearance (SLA) With this BLA configuration, the 8001 DeskPhone set monitors a shared line status.

NOTE: ONLY WHEN YOU CHOOSE "SPEED DIAL", THE RIGHT OF "NAME","NUMBER" WILL TAKE EFFECT.

6.4 Function Keys

Function Keys: If you do not like the default setting with the function keys feature. You can change to whatever you want.

NOTE: IF THE PHONE DOESN'T HAVE THE KEY, PLEASE IGNORE IT.

	Operation	Account	Name	Number
Up:	Contacts	Account1		
Down:	Redial	Account1		
Left:	Default	Account1		
Right:	Default	Account1		
OK:	Redial	Account1		
Conference:	DND	Account1		
Redial:	Contacts	Account1		
Transfer:	Enterprise Phonebook	Account1		
Hold:	LDAP	Account1		
Service:	Dir	Account1		
Directories:	Speed Dial	Account1		
Menu:	Call List	Account1		
Mute:	Missed Calls	Account1		
Message:	Received Calls	Account1		
	Dialed Calls	Account1		
	Menu	Account1		
	SMS	Account1		
	New SMS	Account1		
	Call Forward	Account1		
	View Status	Account1		
	Call Forward	Account1		

6.5 Soft Key

Soft Keys: Soft keys are the keys positioned just below display in the LCD. You can change them to other features and many kinds of status. As shown in the example here-below, when you are in a call with someone, the LCD display soft key is Send \Del \Empty\End, Empty means nothing in it.

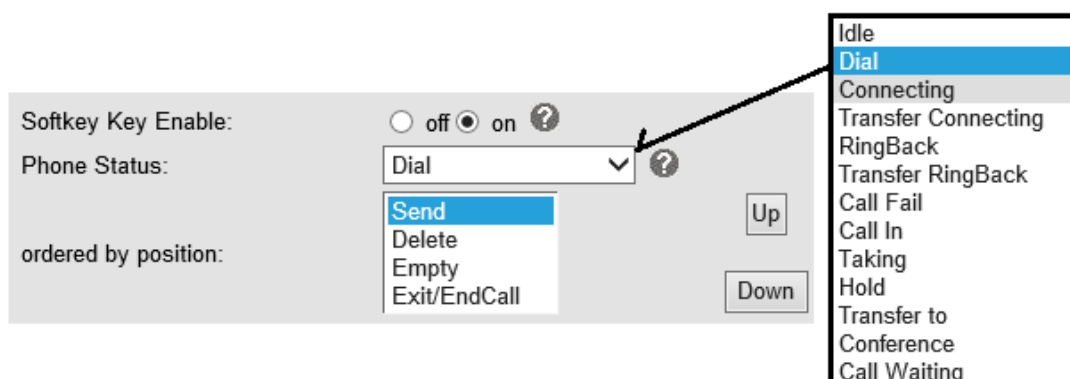

6.6 Dial Plan

If you want to setup a dial plan, you can click "Dial Plan"

<input checked="" type="checkbox"/>	Send Key	<input type="radio"/> * <input checked="" type="radio"/> #		
<input type="checkbox"/>	Dial Length	<input type="text" value="25"/>		
	No Dial Timeout	<input type="text" value="5"/>		
ID	Operation	Prefix	IP Address	Description
<input type="button" value="Add Rule"/>		<input type="button" value="Delete All Rule"/>		

ITEM	DESCRIPTION
Send Key	Select the default send key mode you want to use.
Dial Length	Enable this feature will limit the dial length. Default is 25.
No Dial Timeout	Setting the range with no dial timeout, default is 5.
Dial Rule	Select the Add Rule button to add a dialing rule, please see details here below.

ID	<input type="text" value="1"/>	Description	<input type="text"/>
IP	<input type="text"/>	Port(Default 5060)	<input type="text" value="5060"/>
Prefix	<input type="text"/>		
Called Insert Number	<input type="text" value="Disable"/>	Called Delete Number	<input type="text" value="Disable"/>
Position	<input type="text"/>	Position	<input type="text"/>
Number	<input type="text"/>	Length	<input type="text"/>
<p>(Note: When you want to add code and delete at the same time, you can add code first, after that base on the number you add, decide the position and length of the delete code.)</p>			

ITEM	DESCRIPTION
ID	Dial Plan ID
IP	The IP address of a phone which you want to call
Description	Description with this dial rule.
Port	Setting the Port with this dial rule, default is5060.
Prefix	The number which you need to press actually if you want to call the phone
Called Insert Number	There have two option, Enable or Disable.
Position	Which position you want insert the number
Number	Which number you want to insert
Called Delete Number	There have two option, Enable or Disable.

NOTES: If you want to know more details about Dial Rule, please find it in the official website to download the specific document.

6.7 IP Strategy

You can use IP Strategy feature to make a list which can be set to only allow the incoming call on the list.

e.g. In the following picture if 192.168.0.248 is in the list when you open this feature, it means you just allow incoming calls from this IP address

IP Strategy <input checked="" type="radio"/> off <input type="radio"/> on				
ID	Operation	IP Address	Description	Account

7. Phone Book



The phone book including Group, Contact, LDAP and Ban list, please review the following for more details:

7.1 Group

You can add, edit and delete a group in a phone book on this webpage.

ID	<input type="text" value="2"/>	Description	<input type="text" value="test2"/>
Group Name	<input type="text" value="test2"/>	Ring Type	<input type="text" value="Ring2"/>
<input type="button" value="Submit"/>		<input type="button" value="Cancel"/>	

Click the groupname you can modify or delete the member of the group

ID	Operation	Group Name	Group Member	Description	Ring Type
1	 	test	0	test	Ring1

Attention: If you Click 'Delete Group' or 'Delete All Group', the member of group can not within a group, please click the group and delete the group.

If you want to add a Group, you just need to click 'Add Group'.

You can edit an existing Group by clicking .

You can delete an existing Group by clicking , if you want to delete all Groups, you just need to click 'Delete All Group'.

7.2 Contact

You can add, edit and delete contacts in a phone book on this web page. The phonebook can store 300 contact entries

Serial Number	1	Last Name	test
First Name	test	Office Number	1111
Mobile Number	1111	Account	Account1
OtherNumber	1111	Group2	None
Group1	test		

Delete	ID	Operation	Name	Phone	Group
<input type="checkbox"/>	1		test test	Number1:1111 Number2:1111 Number3:1111	test

Attention:If you want to download or upload the contact,please go to the "Phone Maintenance" page

If you want to add a Contact, you just need to click 'Add Contact'.

You can edit an existing Contact by clicking .

You can delete an existing Contact by clicking , if you want to delete all Contacts, you just need to click 'Delete All Contact'.

You can edit or move this contact to Ban List by selecting .

You can download and save this contact to PC by selecting .

7.3 LDAP

8001 DeskPhone supports LDAP feature, when 8001 DeskPhone works with Alcatel-Lucent system, user can configure LDAP through 8770, while user also can configure standard LDAP by webpage. Here is an example:

e.g.

LDAP Name Filter:(sn=%s)

LDAP Number Filter:(telephoneNumber=%s)

Server Address:192.168.0.65 BASE:DC=ldap,

DC=ALCATEL- LUCENT, DC=com

User Name: bb@ldap.ALCATEL-LUCENT.com

Pass Word: ALCATEL-LUCENT_2012

LDAP Name Attributes 1:sn

LDAP Name Attributes 2:cn



LDAP Number Attributes 1:telephoneNumber

LDAP	<input type="radio"/> on <input checked="" type="radio"/> off ?
LDAP Name Filter	<input type="text" value="(sn=%s)"/> ?
LDAP Number Filter	<input type="text" value="(telephoneNumber=%"/> ?
Server Address	<input type="text" value="192.168.0.65"/> ?
Cwmp Port	<input type="text" value="389"/> ?
Base	<input type="text" value="DC=ldap,DC=escene,"/> ?
Username	<input type="text" value="bb@ldap.escene.com"/> ?
Password	<input type="text" value="escene_2012"/> ?
Max. Hits(1~32000)	<input type="text" value="50"/> ?
LDAP Name Attributes 1	<input type="text" value="sn"/> ?
LDAP Name Attributes 2	<input type="text" value="cn"/>
LDAP Name Attributes 3	<input type="text"/>
LDAP Number Attributes 1	<input type="text" value="telephoneNumber"/> ?
LDAP Number Attributes 2	<input type="text"/>
LDAP Number Attributes 3	<input type="text"/>
Protocol	<input type="radio"/> Version2 <input checked="" type="radio"/> Version3 ?
Search Delay(ms)(0~2000)	<input type="text" value="0"/> ?
LDAP Lookup For Incoming Call	<input checked="" type="radio"/> on <input type="radio"/> off ?
LDAP Lookup For PreDial/Dial	<input checked="" type="radio"/> on <input type="radio"/> off ?

7.4 Ban List

You can add, edit and delete contact in a Ban List on this web page.

Serial Number	<input type="text" value="1"/> ▾	Description	<input type="text" value="test3"/>
First Name	<input type="text" value="test3"/>	Last Name	<input type="text" value="testc"/>
Mobile Number	<input type="text" value="3333"/>		
Home Number	<input type="text" value="3333"/>		
Office Number	<input type="text" value="3333"/>		
Account	<input type="text" value="Auto"/> <input type="text" value="Account1"/> <input type="text" value="Account2"/> <input type="text" value="Account3"/>		
		<input type="button" value="Submit"/>	<input type="button" value="Cancel"/>

ID	Operation	Name	Phone	Description	Account
1	  	test3 testc	Number1:3333 Number2:3333 Number3:3333	test3	Auto

If you want to add a Ban List, you just need to click 'Add Ban List'.

You can edit an existing Ban List by clicking .

You can delete an existing Ban List by clicking , if you want to delete all Ban Lists, you just need to click 'Delete All Ban List'.

You can edit a contact item in a ban list, or move a contact from a ban list to a regular group by selecting .

8. Phone Maintenance

8.1 Basic

NOTES: Don't cut off the electricity or network cable when doing upgrade with the below described methods!

8.1.1 HTTP Upgrade

You can upgrade the software, kernel and configuration etc. files by HTTP.

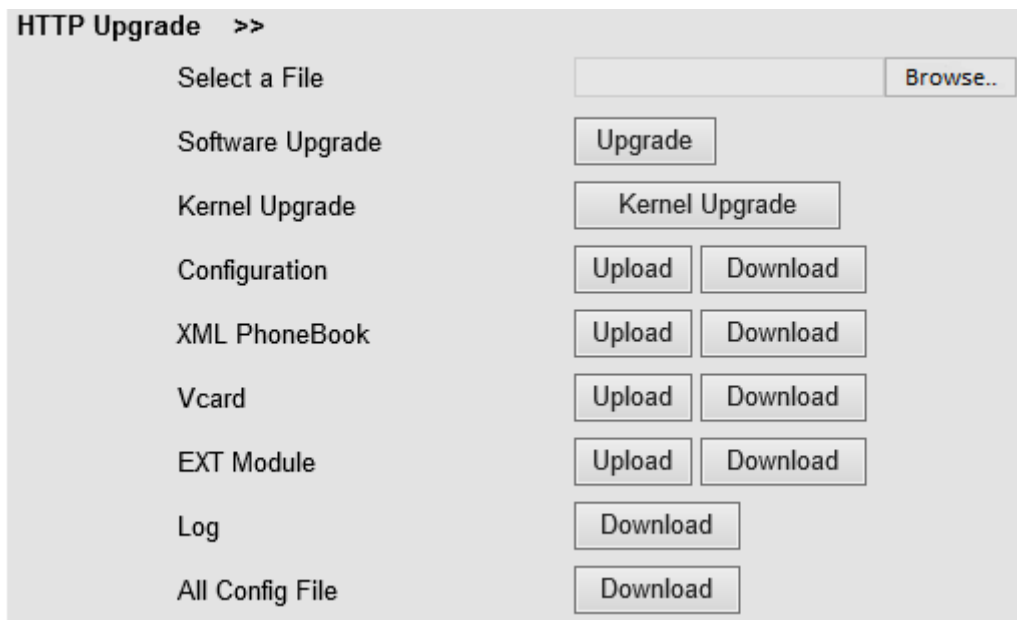

The screenshot shows a web interface titled "HTTP Upgrade >>". It contains a list of upgrade options on the left and corresponding buttons on the right. The options and buttons are:

Option	Buttons
Select a File	<input type="text"/> Browse..
Software Upgrade	Upgrade
Kernel Upgrade	Kernel Upgrade
Configuration	Upload Download
XML PhoneBook	Upload Download
Vcard	Upload Download
EXT Module	Upload Download
Log	Download
All Config File	Download

When using HTTP upgrade, you can set several parameters as follow:

HTTP Upgrade	
Select a File	Browse the software/kernel/configuration file which you need to upgrade from HTTP
Software Upgrade	Used for upgrading the software of the phone

Kernel Upgrade	Used for upgrading the kernel of the phone
Configuration	You can use upload/download to upload/download the configuration file of the phone
XML Phone Book	Used for uploading/downloading the XML phonebook of the phone
Vcard	Downloading all contacts in the Vcard mode, but upload only support one by one transfer.
EXT Module	8001 DeskPhone doesn't support this feature
Log	Used by the administrator for troubleshooting.
All Config File	All Config File includes: Configuration, Extern, Log, XML Phone book, Enterprise Phone Book.

8.1.2 FTP Upgrade

You can upgrade the software, kernel and configure files by FTP.

FTP Upgrade >>

Server IP

Filename

Username

Password

Software Upgrade

Kernel Upgrade

Note: It's no necessary to input filename when backup.

Configuration

Phone Book

EXT Module

When using FTP upgrade, you can set several parameters as follow:

FTP Upgrade	
Server IP	The IP address of the FTP server
Filename	Name of the file to Download from the FTP server
Username	Provided by FTP server
Password	Provided by FTP server
Software Upgrade	Used for upgrading the software of the phone
Kernel Upgrade	Used for upgrading the kernel of the phone

Configuration	Used for updating/backup of the configuration file of the phone
Phone Book	Used for updating/backup of the phonebook of the phone
EXT Module	This phone doesn't support this feature

NOTES: It's not necessary to input filename when doing backup Configuration, Phone Book.

8.1.3 TFTP Upgrade

You can upgrade the software, kernel and configure files by TFTP.

TFTP Upgrade >>

Server IP

Filename

Software Upgrade

Kernel Upgrade

Note: It's no necessary to input filename when backup.

Configuration

Phone Book

EXT Module

When use TFTP upgrade, you can set several parameters as follow:

TFTP Upgrade	
Server IP	The IP address of the TFTP server
Filename	Name of the file to Download from the TFTP server
Software Upgrade	Used for upgrading the software of the phone
Kernel Upgrade	Used for upgrading the kernel of the phone
Configuration	Used for updating/backup of the configuration file of the phone
Phone Book	Used for updating/backup of the phonebook of the phone
EXT Module	This phone doesn't support this feature

NOTES: It's not necessary to input filename when doing backup Configuration, Phone Book.

8.1.4 Default Setting

You can load the phone to the factory default setting in "default setting" option.



Press the 'Reset to Factory Setting' option, the phone will load to factory default setting on next reboot.

8.1.5 Reboot

You can use reboot option to reboot the phone.

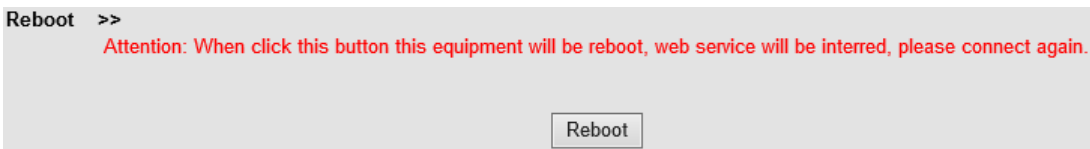

8.2 Advanced

8.2.1 Log

This feature is used by the administrator to manage the equipment, like debugging, SIP etc. If you want to set the 8001 Deskphone to a one of the debugging levels, you need to use the following user interface.

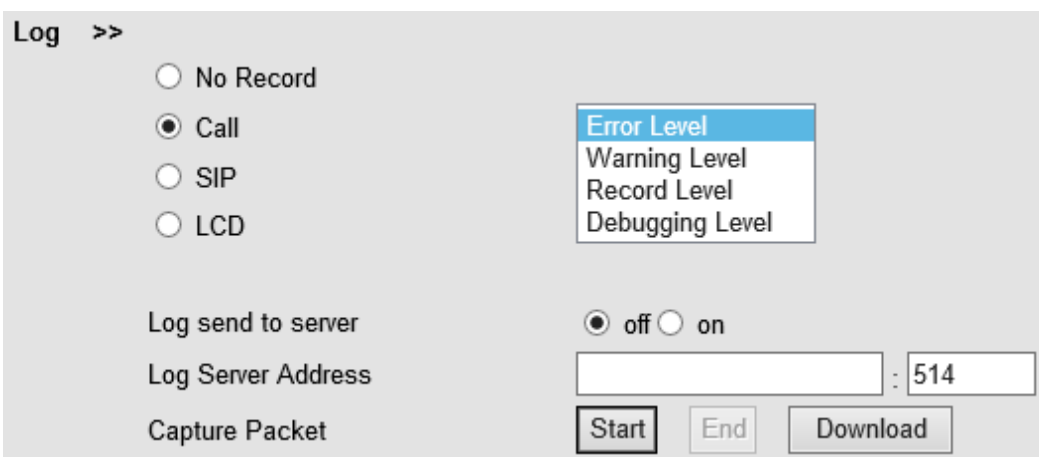

8.2.2 Auto Provision

When you open this auto provision feature, the phone will do auto provisioning after it detects a different software or kernel (Higher or Lower) which are put on the TFTP, HTTP, HTTPS, FTP, server.

Auto Provision >>

Auto Provision on off

Option: (Default :66, Min:1, Max:254)

Protocol ▼

Software Server URL

Username

Password

Auto Download Software

Auto Download Kernel

Auto Download Config File

Auto Download Expansion

Auto Download Enterprise Phonebook

Auto Download Personal Phonebook

Bootling Checked

Disable the phone while bootling checking off on

Auto Provision Frequency Hour (Default :7 days, Max:30 days)

Auto Provision Time ▼

Auto Provision Next Time Thu Aug 8 12:24:00 2013

AES Enable off on

AES Key

When using auto provision, you can set several parameters as follow:

Auto Provision	
Auto Provision	You can enable/disable auto provision by select on/off
Protocol	Used for auto provision, it includes TFTP/HTTP/FTP
Software Server URL	The server address of the auto provision
Username	Provided by provision server
Password	Provided by provision server
Auto Download Software	Used to auto download software from the server
Auto Download Kernel	Used to auto download kernel from the server
Auto Download Config File	Used to auto download configuration file from the server
Auto Download Expansion	NOTES: This phone doesn't support this feature.
Auto Download Enterprise Phonebook	Used to auto download Enterprise Phonebook from the server
Auto Download Personal Phonebook	Used to auto download personal phonebook from the server
Bootling Checked	Used to check the auto provision when the phone is bootling
Disable the phone while bootling checking	Enable/Disable the bootling check feature.
Auto Provision Frequency	Used to set the time interval for auto provision
Auto Provision Time	Used to specify/schedule the time of auto provision
Auto Provision Next Time	Reset the Auto Provision Next Upgrading time.

AES Enable	You can enable/disable AES encryption for auto provision
AES Key	The key of the AES
Auto Provision Now	Used for doing auto provision immediately

9. Password

Here you can set the administrator or user's WEB password. If you login as an administrator, you can modify both the user's and admin's passwords.

Administrator User

Username	<input type="text" value="root"/>
Old Password	<input type="text"/>
New Password	<input type="text"/>
Confirm Password	<input type="text"/>

10. WEB and Settings or Information

10.1 WEB User

In the upper right corner of the website page, you can select the user or logout.



10.2 Note Tips

In the right middle of the website page, there is a Note tips in every function page. Hope it can help you to know something about that.

Note

Register status:

It shows the Register Status.

Network Status:

It shows the information of LAN port and PC port.

System Info:

It shows the version of firmware